

SLIDING DOOR ROLLERS

QUOTE REQUEST INFORMATION:

_____ = DOORS PER YEAR FORECAST
 _____ = BEARING MATERIAL

1981 SERIES
SIDE ADJUST TANDEM AXLE
 BOX QTY: 50

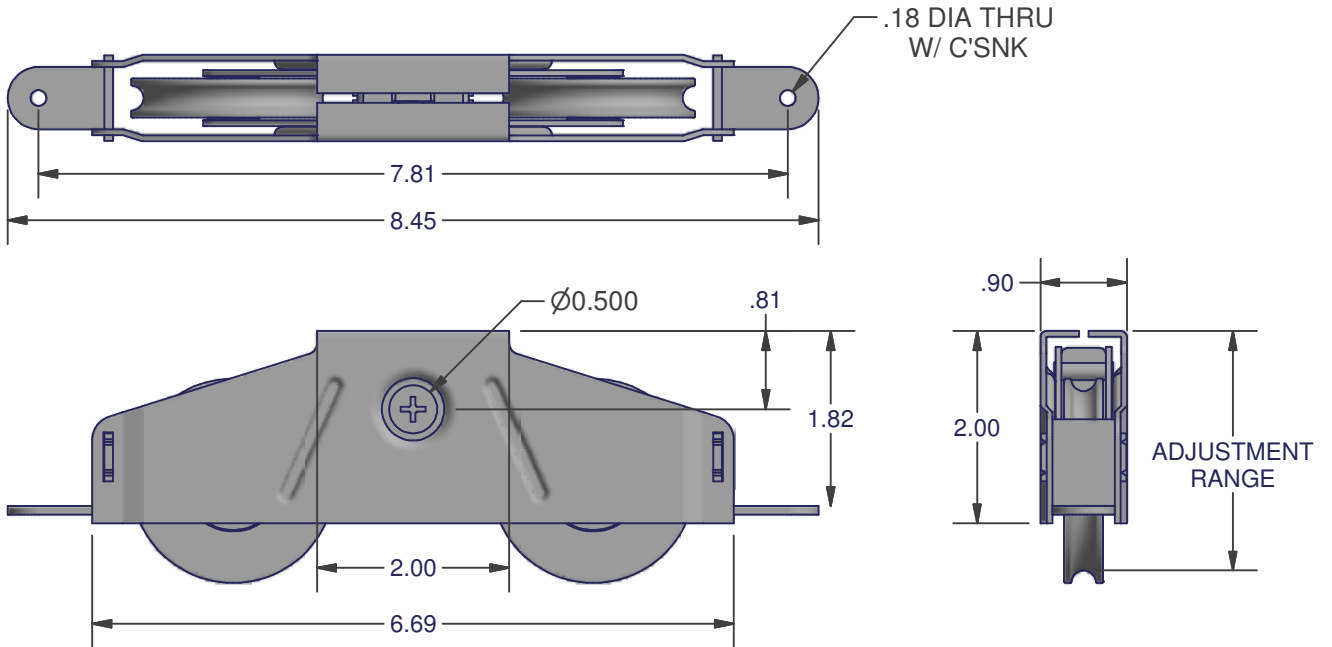
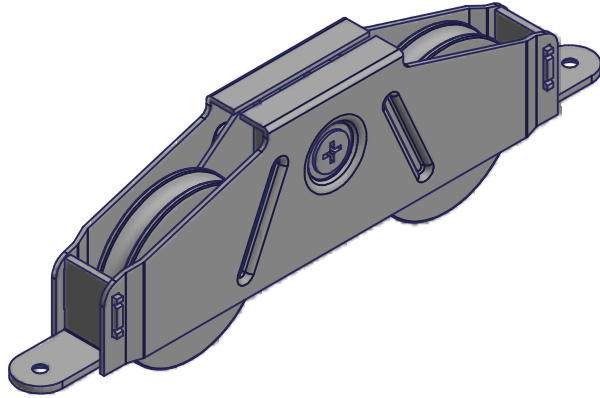

MOST COMMON: PRS

HOUSING MATERIAL	WHEEL DIA.	ADJUSTMENT RANGE	BEARING MATERIALS
SS	2.12	2.40-2.80	PRN, PRS

LEGEND			
CODE	DESCRIPTION	CODE	DESCRIPTION
TBN	NYLON WHEEL W/ STEEL BEARING	S	MILD STEEL W/ YZD PLATING WHEEL & BEARING
BNSS	NYLON WHEEL W/ STAINLESS STEEL BEARING	PST	STEEL WHEEL W/ PRECISION BEARING
PRN	NYLON WHEEL W/ PRECISION BEARING	SS	STAINLESS STEEL WHEEL & BEARING
		PRS	STAINLESS STEEL WHEEL W/ PRECISION BEARING

DIMENSIONS ARE FOR REFERENCE ONLY AND ARE IN INCHES UNLESS OTHERWISE NOTED.
 CONTACT OUR ENGINEERING DEPARTMENT WITH SPECIFIC APPLICATION QUESTIONS OR REQUIREMENTS.
 NOT ALL COMBINATIONS LISTED ARE CURRENTLY STOCKED, EXTRA LEAD TIME MAY BE REQUIRED.