

# ACCESSORIES

## SNUBBER

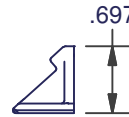
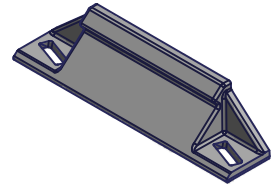
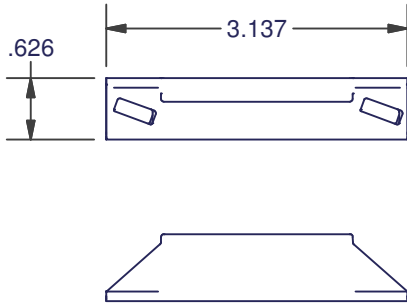

21-000-0-62-000

## SNUBBER

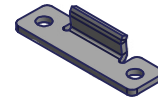
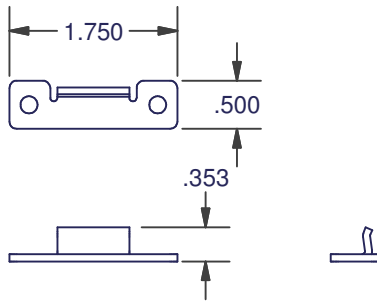

17-001-0-01-000 NON HANDED

## OPERATOR SPACER

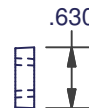
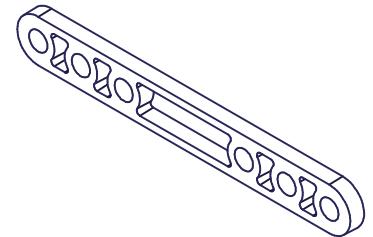
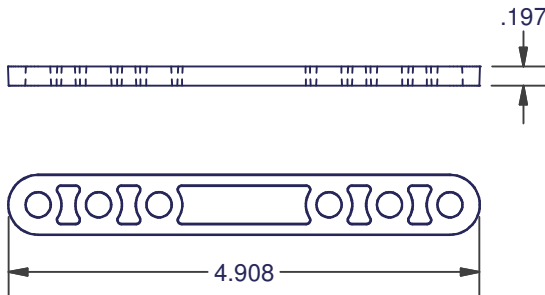

20-003-0-00-000 NON HANDED

## TRACK & SLIDER

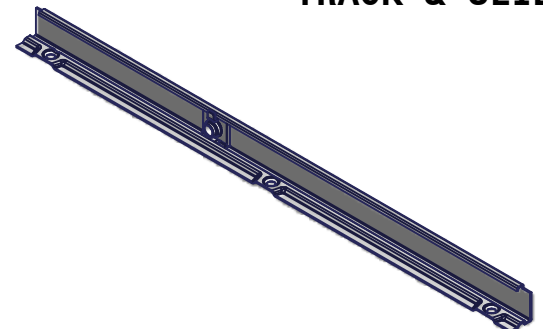

10-000-0-01-000 NON HANDED

DIMENSIONS ARE FOR REFERENCE ONLY AND ARE IN INCHES UNLESS OTHERWISE NOTED.  
CONTACT OUR ENGINEERING DEPARTMENT WITH SPECIFIC APPLICATION QUESTIONS OR REQUIREMENTS.  
NOT ALL COMBINATIONS LISTED ARE CURRENTLY STOCKED, EXTRA LEAD TIME MAY BE REQUIRED.