

AUTOLOCKS & KEEPERS

4745-26

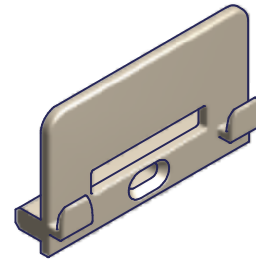
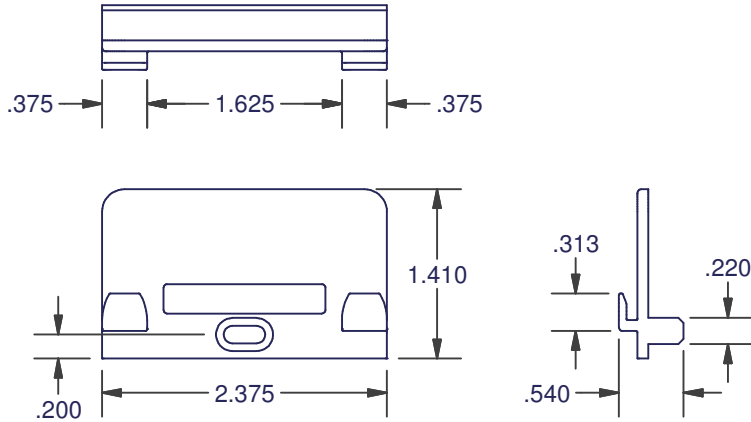

AMESBURY ITEM #	REFERENCE ITEM #
400288	4745-26

MATERIAL: ZINC

4745-29

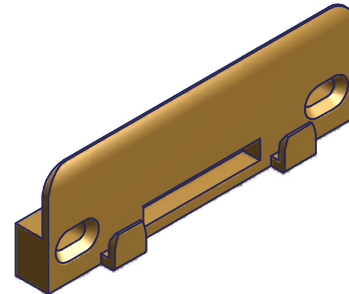
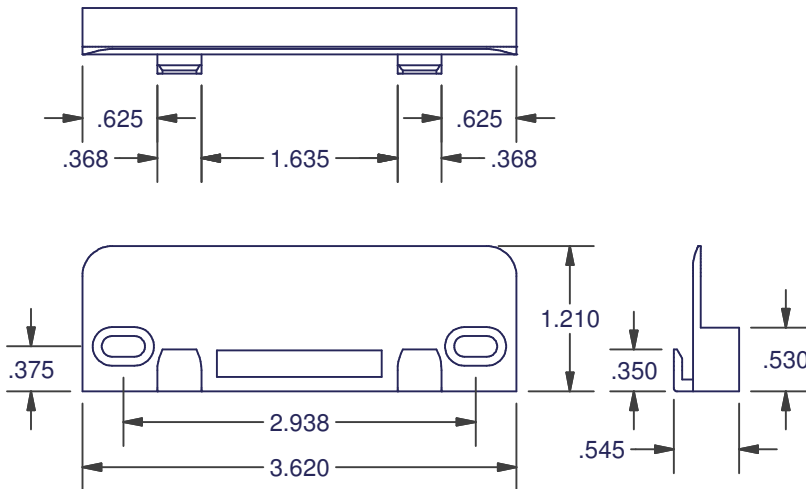

AMESBURY ITEM #	REFERENCE ITEM #
400289	4745-29

MATERIAL: ZINC

4745-32

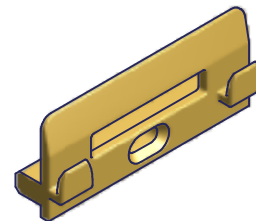
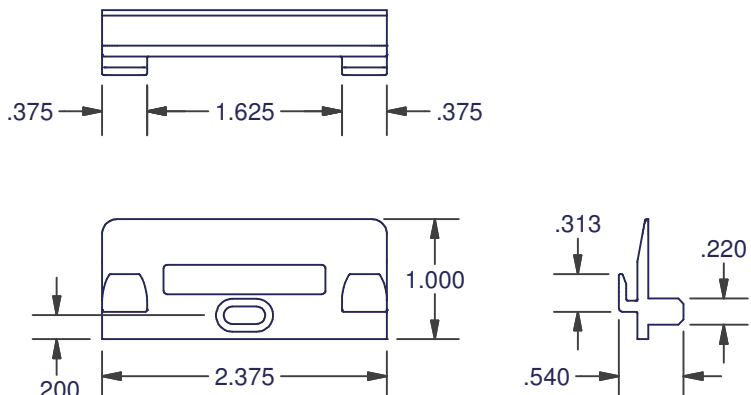

AMESBURY ITEM #	REFERENCE ITEM #
400290	4745-32

MATERIAL: ZINC

DIMENSIONS ARE FOR REFERENCE ONLY AND ARE IN INCHES UNLESS OTHERWISE NOTED.
CONTACT OUR ENGINEERING DEPARTMENT WITH SPECIFIC APPLICATION QUESTIONS OR REQUIREMENTS.
NOT ALL COMBINATIONS LISTED ARE CURRENTLY STOCKED, EXTRA LEAD TIME MAY BE REQUIRED.